



BUILT WITH PASSION.
OWNED WITH PRIDE.



FIREMAGIC PREMIUM OUTDOOR GRILLS COLLECTION CATALOGUE 2014

CRAFTED WITH PRIDE  IN THE USA

PREMIUM OUTDOOR GRILLS



For more than 75 years, Fire Magic® has been building the world's finest outdoor grills for people who demand the highest quality and performance. Our passion for manufacturing premium grills will be felt in the pride of ownership that you'll enjoy for a lifetime.

Constructed entirely of the finest quality, heavy gauge 304 stainless steel with unsurpassed attention to the most precise detail in design and construction, Fire Magic® Grills are the most elegant, and the most durable barbecues available. They easily perform at the highest temperatures for the longest time of any outdoor barbecue grill. With unique features like our advanced heating distribution system, a searing option, smoking capability, most complete rotisserie cooking, and even charcoal grilling, Fire Magic® offers a truly unmatched grilling experience.

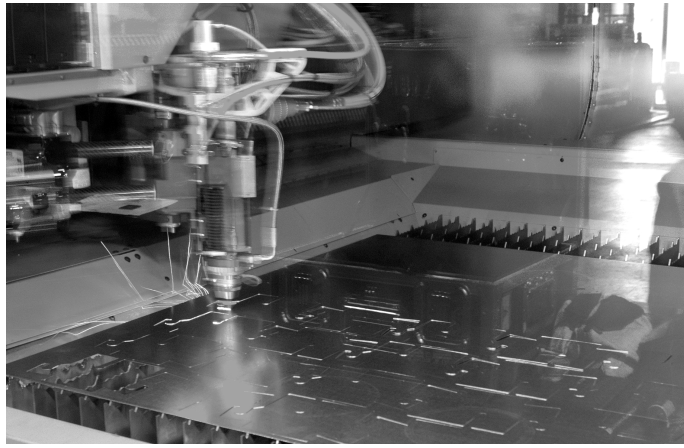

Every Fire Magic® product is manufactured in our USA production facility and held to the strictest safety standards and the highest performance metrics. Using state-of-the-art technology guided by the watchful eye and careful hand of master craftsmen, our grills are an investment that pays dividends for years and years. They are engineered and built to perform for a lifetime. The pride and joy from owning your Fire Magic® Grill will last for years to come.

BUILT WITH PASSION.
OWNED WITH PRIDE.

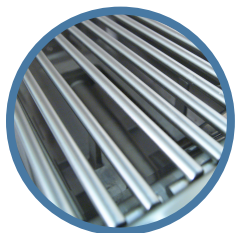

HEAVY DUTY STAINLESS STEEL COOKING GRIDS



MULTI-COLOURED BACKLIT THERMOMETER

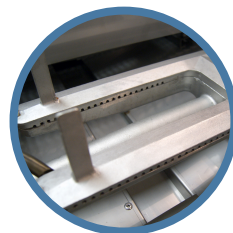

EXCLUSIVE CAST STAINLESS STEEL "E" BURNERS



OPTIONAL MAGIC VIEW WINDOW



HOT SURFACE IGNITION

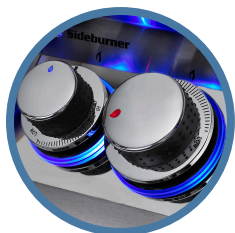

COMFORT TOUCH BLUE BACKLIT KNOBS



SLEEK LINES & CONTOURED FACE

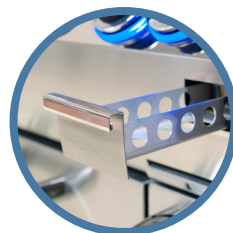

WOODCHIP SMOKER DRAWER

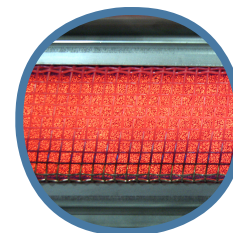

QUANTUM BACKBURNER



HALOGEN LIGHTS



ECHELON

 DIAMOND SERIES

BUILT-IN & STAND ALONE GRILLS

» DISCOVER THE DIFFERENCE

- » All 304 Stainless Steel Construction
- » Cast stainless steel "E" burners for consistent, even heat distribution, guaranteed for life (optional infrared burners are available)
- » Most kW and heat per square centimeter. Heats fast and stays hot
- » Largest cooking space compared to other same sized grills
- » 16 gauge stainless steel, Flavour grids are engineered for durability, even heat distribution and reduced flare-ups
- » Feather-Lite, easy-lift oven hood with spring assist
- » Meat Probe with multi functional digital thermometer read-out
- » 30 cm deep fire box (top to bottom). Provides the most complete convection cooking
- » Angled interior halogen lights for evening grilling
- » 56cm long watertight wood chip smoker box with 1 kW dedicated burner
- » Hot surface electronic ignition - lights every time
- » Master power switch turns off electrical system when not in use
- » Recessed Quantum Backburner that uses less kW to generate high heat making it ideal for efficient, versatile rotisserie cooking
- » Heavy-duty rotisserie spit rod with roller ball-bearings support and super-high torque motor
- » Built-in storage brackets for rotisserie spit rod
- » Fully illuminated safety control knobs (flame turns red when on)
- » Integral, and removable, oven warming rack for light cooking or warming foods
- » Customized stainless steel name plaque to personalize your grill
- » Heat zone separators isolate cooking areas so food in each section may be grilled at different temperatures
- » Built-in grill is field convertible (natural gas/ propane gas)
- » Optional Magic View Window to check on food without lifting hood

ECHELON

DIAMOND SERIES

BUILT-IN GRILLS



MODEL: E1060i-4E1P*-W-EC

COOKING SURFACE	Primary: 6813 sq. cm [122cm x 56cm] Secondary: 2477 sq. cm [122cm x 20cm]	**
MAX OUTPUT	33 kW Primary + (2) 3 kW Backburners + 1 kW Dedicated Smoker Burner	
CUT-OUT	127cm w x 60cm d x 30cm h	

Model shown optional Magic View Window.



MODEL: E790i-4E1P*-EC

COOKING SURFACE	Primary: 5110sq. cm [91cm x 56cm] Secondary: 1858 sq. cm [91cm x 20cm]	**
MAX OUTPUT	28 kW Primary + 4 kW Backburner + 1 kW Dedicated Smoker Burner	
CUT-OUT	94cm w x 60cm d x 30cm h	



MODEL: E660i-4E1P*-EC

COOKING SURFACE	Primary: 4258 sq. cm [76cm x 56cm] Secondary: 1548 sq. cm [76cm x 20cm]	**
MAX OUTPUT	22 kW Primary + 3 kW Backburner + 1 kW Dedicated Smoker Burner	
CUT-OUT	79cm w x 60cm d x 30cm h	

*All models available in natural gas or propane (for natural change P to N).
** The warming rack is the secondary cooking surface on the grill



MODEL: E1060s-4E1P*-62-W-EC

COOKING SURFACE	Primary: 6813 sq. cm [122cm x 56cm] ** Secondary: 2477 sq. cm [122cm x 20cm]
-----------------	---

MAX OUTPUT	33 kW Primary + (2) 3 kW Backburners + 1 kW Dedicated Smoker Burner + 9 kW Double Side Burner
------------	--

Model shown with optional Magic View Window. Also available with a Double Side Burner (-71) or Single Side Burner option (-62).

ECHELON

DIAMOND SERIES

STAND ALONE GRILLS



MODEL: E790s-4E1P*-71-EC

COOKING SURFACE	Primary: 5110 sq. cm [91cm x 56cm] ** Secondary: 1858 sq. cm [91cm x 20cm]
-----------------	---

MAX OUTPUT	28 kW Primary + 4 kW Backburners + 1 kW Dedicated Smoker Burner + 9 kW Double Side Burner
------------	--

Model shown with Double Side Burner. Also available with a Single Side Burner Option (-62).



MODEL: E660s-4E1P*-62-EC

COOKING SURFACE	Primary: 4258 sq. cm [76cm x 56cm] ** Secondary: 1548 sq. cm [76cm x 20cm]
-----------------	---

MAX OUTPUT	22 kW Primary + 3 kW Backburners + 1 kW Dedicated Smoker Burner + 4 kW Single Side Burner
------------	--

Model shown with Single Side Burner. Also available with a Double Side Burner Option (-71).

*All models available in natural gas or propane (for natural change P to N).
** The warming rack is the secondary cooking surface on the grill



HEAVY DUTY STAINLESS STEEL COOKING GRIDS



BUILT-IN DIGITAL THERMOMETER

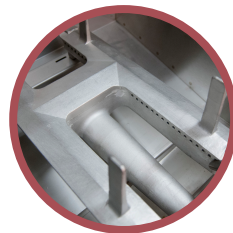

EXCLUSIVE CAST STAINLESS STEEL "E" BURNERS



SPRING ASSISTED LID



COMFORT TOUCH KNOBS



BEAUTIFUL GOURMET FACE

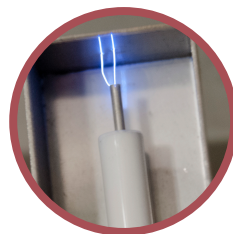

ELECTRONIC PUSH-TO-LIGHT SPARK IGNITION



STAINLESS STEEL BACKBURNER



AURORA

S E R I E S

BUILT-IN & STAND ALONE GRILLS

» FEATURE HIGHLIGHTS

- » All 304 Stainless Steel Construction
- » Cast stainless steel "E" burners for consistent, even heat distribution, guaranteed for life (optional infrared burners are available)
- » Most kW and heat per square centimeter. Heats fast and stays hot
- » Largest cooking space compared to other same sized grills
- » 16 gauge stainless steel, Flavour grids are engineered for durability, even heat distribution and reduced flare-ups
- » Feather-Lite, easy-lift oven hood with spring assist
- » Meat Probe with digital thermometer read-out
- » 30 cm deep fire box (top to bottom). Provides the most complete convection cooking
- » Electronic push-to-light spark ignition system
- » Easy to use drip collection system
- » Optional recessed stainless steel rotisserie backburner and heavy duty rotisserie kit
- » (2) four-skewer meat holders with heavy counter balance
- » Built-in storage rack for rotisserie spit rod
- » Comfort touch heavy-duty control knobs
- » Integral and removable, oven warming rack for light cooking or warming foods
- » Sleek styling with seamless control panel
- » A grill of superior design and engineering -- crafted for cooking versatility, durability, and longevity
- » Built-in grill is convertible (natural gas/propane gas)

AURORA

S E R I E S

BUILT-IN GRILLS



MODEL: A790i-2E1P*-EC

COOKING SURFACE	Primary: 2012 sq. cm [91cm x 56cm] ** Secondary: 732 sq. cm [91cm x 20cm]
MAX OUTPUT	26 kW Primary + 6 kW Backburner
CUT-OUT	96cm w x 60cm d x 30cm h



MODEL: A660i-2E1P*-EC

COOKING SURFACE	Primary: 4258 sq. cm [76cm x 56cm] ** Secondary: 1548 sq. cm [76cm x 20cm]
MAX OUTPUT	22 kW Primary + 5 kW Backburner
CUT-OUT	81cm w x 60cm d x 30cm h

MODEL: A540i-2E1P*-EC

COOKING SURFACE	Primary: 3484 sq. cm [76cm x 46cm] ** Secondary: 1548 sq. cm [76cm x 20cm]
MAX OUTPUT	18 kW Primary + 5 kW Backburner
CUT-OUT	81cm w x 50cm d x 30cm h



MODEL: A530i-2E1P*-EC

COOKING SURFACE	Primary: 3406 sq. cm [61cm x 56cm] Secondary: 1239 sq. cm [61cm x 20cm]
MAX OUTPUT	18 kW Primary + 4 kW Backburner
CUT-OUT	65cm w x 60cm d x 30cm h

MODEL: A430i-2E1P*-EC

COOKING SURFACE	Primary: 2787 sq. cm [61cm x 46cm] ** Secondary: 1239 sq. cm [61cm x 20cm]
MAX OUTPUT	15 kW Primary + 4 kW Backburner
CUT-OUT	65cm w x 50cm d x 30cm h

*All models available in natural gas or propane (for natural change P to N.) // All models (except A790) also available without backburner & rotisserie. Change the 6th digit to a "1"
** The warming rack is the secondary cooking surface on the grill

AURORA

S E R I E S

STAND ALONE GRILLS



MODEL: 5110-32
Optional stainless steel
LP tank shield

MODEL: A430s-2E1P*-P6-EC

COOKING SURFACE	Primary: 2787 sq. cm [61cm x 46cm] Secondary: Primary: 1239 sq. cm [61cm x 20cm]
MAX OUTPUT	15 kW Primary + 4 kW Backburner



MODEL: A530i-2E1P*-62-EC

COOKING SURFACE	Primary: 3406 sq. cm [61cm x 56cm] ** Secondary: 1239 sq. cm [61cm x 20cm]
MAX OUTPUT	18 kW Primary + 4 kW Backburner + 4 kW Single Side Burner

MODEL: A430s-2E1P*-62-EC

COOKING SURFACE	Primary: 2787 sq. cm [61cm x 46cm] ** Secondary: 1239 sq. cm [61cm x 20cm]
MAX OUTPUT	15 kW Primary + 4 kW Backburner + 4 kW Single Side Burner



MODEL: A660i-2E1P*-62-EC

COOKING SURFACE	Primary: 4258 sq. cm [76cm x 56cm] ** Secondary: 1548 sq. cm [76cm x 20cm]
MAX OUTPUT	22 kW Primary + 5 kW Backburner + 4 kW Single Side Burner

MODEL: A540i-2E1P*-62-EC

COOKING SURFACE	Primary: 3484 sq. cm [76cm x 46cm] ** Secondary: 1548 sq. cm [76cm x 20cm]
MAX OUTPUT	18 kW Primary + 5 kW Backburner + 4 kW Single Side Burner

*All models available in natural gas or propane (for natural change P to N). // All models also available without backburner & rotisserie. Change the 6th digit to a "1"
** The warming rack is the secondary cooking surface on the grill

LEGACY

DELUXE & COUNTERTOP GRILLS

DELUXE GRILLS



PATIO POST
MODEL: 21-S1S1P*-P6

MODEL: 5110-32
Optional stainless steel
LP tank shield

Includes timer on post. Also available as an in-ground post model. (Change "P6" to "G6")



MODEL: 11-S1S1P*-A-EC

COOKING SURFACE	2374 sq. cm [58cm x 41cm]
MAX OUTPUT	12 kW Primary
CUT-OUT	63cm w x 45cm d x 30cm h

- Heavy-duty stainless steel construction
- Optional infrared burner

COUNTERTOP GRILLS



MODEL: 3C-S1S1P*-A-EC (pictured)

COOKING SURFACE	368 sq. cm [58cm x 41cm]
MAX OUTPUT	12 kW Primary
CUT-OUT	75cm w x 42cm d x 36cm h

MODEL: 34-S2S1P*-A-EC

COOKING SURFACE	3484 sq. cm [76cm x 46cm]
MAX OUTPUT	19 kW Primary
CUT-OUT	105cm w x 52cm d x 46cm h

Optional Rotisserie Backburner 6 kW

MODEL: 31-S1S1P*-A-EC

COOKING SURFACE	2374 sq. cm [58cm x 41cm]
MAX OUTPUT	12 kW Primary
CUT-OUT	62cm w x 49cm d x 31cm h

*All models available in natural gas or propane (for natural change P to N).



MODEL: 24-SC01C-61 (pictured)

COOKING SURFACE	Primary: 3484 sq. cm [76cm x 46cm] Secondary: 1032 sq. cm [51cm x 20cm]
-----------------	--

MODEL: 22-SC01C-61

COOKING SURFACE	Primary: 2787 sq. cm [61cm x 46cm] Secondary: 1187 sq. cm [58cm x 20cm]
-----------------	--

Classic rounded oven hood also available



MODEL: 14-SC01C-A (pictured)

COOKING SURFACE	Primary: 3484 sq. cm [76cm x 46cm] Secondary: 1032 sq. cm [51cm x 20cm]
-----------------	--

CUT-OUT	82cm w x 50cm d x 30cm h
---------	--------------------------

MODEL: 12-SC01C-A

COOKING SURFACE	Primary: 2787 sq. cm [61cm x 46cm] Secondary: 1187 sq. cm [58cm x 20cm]
-----------------	--

CUT-OUT	67cm w x 50cm d x 30cm h
---------	--------------------------

CHARCOAL

CHARCOAL GRILLS & SMOKER



FIREMASTER

MODEL: 3324*

COOKING SURFACE	3484 sq. cm [76cm x 46cm]
-----------------	---------------------------

CUT-OUT	79cm w x 54cm d x 31cm h
---------	--------------------------

MODEL: 3329*

COOKING SURFACE	2374 sq. cm [58cm x 41cm]
-----------------	---------------------------

CUT-OUT	62cm w x 49cm d x 31cm h
---------	--------------------------

- Designed to drop into the top of your island
- Adjustable charcoal pan for easy cooking control



LIFT-A-FIRE

MODEL: 3334*

COOKING SURFACE	3484 sq. cm [76cm x 46cm]
-----------------	---------------------------

CUT-OUT	82cm w x 50cm d x 31cm h
---------	--------------------------

MODEL: 3339*

COOKING SURFACE	2374 sq. cm [58cm x 41cm]
-----------------	---------------------------

CUT-OUT	63cm w x 45cm d x 31cm h
---------	--------------------------

- Constructed of heavy-duty steel with durable powder coated enamel finish
- Adjustable charcoal pan for easy cooking control

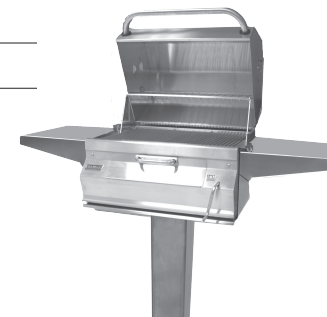

MODEL: 22-SC01C-G6 (pictured)
IN-GROUND POST

COOKING SURFACE	2787 sq. cm [61cm x 46cm]
-----------------	---------------------------

MODEL: 22-SC01C-P6
PATIO POST

COOKING SURFACE	2787 sq. cm [61cm x 46cm]
-----------------	---------------------------

*Cooking grids and ovens (if desired) for Firemaster & Lift-A-Fire Slide-In must be ordered separately.

ACCESSORIES

SIDE BURNERS, REFRIGERATION
& MORE



CUT & CLEAN COMBO
MODEL: 53816
CUTOUT: 41cm w x 39cm d x 38cm h

Allows you to slice and dice on a Fire Magic® bamboo cutting board, then sweep debris right into the Fire Magic® trash receptacle or basic trash can via a deep stainless steel trash chute. Chute measures 37 cm.



BAR CADDY
MODEL: 1D-S0
CUTOUT: 36cm w x 57cm d x 31cm h

Bar Caddy comes equipped with a towel bar, bottle opener, sliding storage drawer, two stainless steel bottle sleeves and an installation hanger. Available with the optional steam warming accessory.



SIDE BURNER COUNTERTOP
MODEL: 3280P-EC
CUTOUT: 22cm w x 36cm d

Drops into the top of island. Features include 4 kW sealed burner, precise flame control valve, and stainless steel cover.



ECHELON DBL SIDE BURNER
MODEL: 32814P-EC
CUTOUT: 29cm w x 58cm d x 31cm h

Enjoy precise flame control on each burner to prepare side dishes and sauces for your meal (Two [2] 4 kW burners). Available with porcelain cast or stainless steel grids.



ECHELON SIDE BURNER
MODEL: 32794-1P-EC
CUTOUT: 29cm w x 36cm d x 31cm h

The Echelon Single Side Burner features a 4 kW burner, precise flame control valve, and stainless steel cover. Available with porcelain cast grid.



DOUBLE SIDE BURNER
MODEL: 3281P-EC
CUTOUT: 29cm w x 58cm d x 31cm h

The Double side burner offers precise flame control on each burner to prepare side dishes and sauces for your meal (Two [2] 4 kW burners). Available with porcelain cast or stainless steel grids.



SINGLE SIDE BURNER
MODEL: 3279-1P-EC
CUTOUT: 29cm w x 36cm d x 31cm h

Features of this single side burner include a 4 kW burner, and precise flame control valve. Available with porcelain cast grid.

All Fire Magic® sideburners include stainless steel lid.



TRASH CONTAINER
MODEL: 53825-T
CUTOUT: 32cm w x 51cm d x 61cm h

Constructed of stainless steel with a hands-free foot lever, the door easily slides open to reveal a 44 Litres trash can. Fully enclosed.



BAMBOO CUTTING BOARD
MODEL: 3582-1

This durable and functional Bamboo Cutting Board is perfect for preparing meats and vegetables for grilling. 30cm x 35cm.



REFRESHMENT CENTER
MODEL: 3596
CUTOUT: 65cm w x 60cm d x 31cm h

Insulated walls, bottom drain, in-front shelving, attached bottle opener, dual sliding removable doors, included drain kit, and Echelon styled face.

ACCESSORIES

SIDE BURNERS, REFRIGERATION
& MORE



GRIDDLE
MODEL: 3512A or 3513A

Griddle available for the Fire Magic® double side burner as well as the Echelon and Aurora grills. Perfect for breakfast, grilled or vegetables or fajitas.



SINK & FAUCET
MODEL: 3587 & 3588
CUTOUT: 36cm w x 36cm d x 43cm h

Adds convenience and functionality to your outdoor kitchen. Purchase separately or together. Sink measures 38cm x 38cm x 15cm and requires a 43cm clearance underneath.



PAPER TOWEL HOLDER
MODEL: 53812
CUTOUT: 31cm w x 20cm d x 24cm h

Accepts and protects regular or jumbo rolls.



WOK
MODEL: 3572

Hard-anodised stick-resistant lined interior surface measures 36cm in diameter.

ACCESSORIES

SIDE BURNERS, REFRIGERATION
& MORE



GRILL COVERS
MODELS: Various "E" Styles

Custom fitted to Fire Magic® grills and accessories, these rip stop fabric covers look great and are double stitched for durability.



GRILL BRUSH
MODEL: 3576-1

The brass bristles on Fire Magic's® Grill Brush make clean up fast and easy. Includes one replacement brush head. Replacement brush heads also available.



FOUR-PIECE TOOL SET
MODEL: 3575

Includes a fork, spatula, knife and tongs. Constructed of quality stainless steel.



CHICKEN HOLDER
MODEL: 3617E

Enjoy a golden, succulent chicken the quick and easy way!



DISPOSABLE DRIP TRAY LINER
MODEL: 3557 (4-PACK)

Custom-designed for Fire Magic® grills and sold in packs of 4, these convenient disposable drip tray liners reduce the risk of grease fires.



CHARCOAL BASKET
MODEL: 3562-1 (33cm x 25cm)
MODEL: 3562-2 (41cm x 25cm)

Cooking with wood chunks or charcoal is easier than ever. Basket sits on top of the burner, gas burners ignite the chunks or coals. Bottom tray catches ashes for easy clean-up.

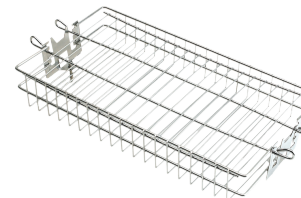

ROTISSERIE BASKET
MODEL: 3618

A versatile, stainless steel basket for skewers, burgers, ribs or fish.



STAINLESS STEEL CLEANER
MODEL: 3581-6 (6-Pack)

Protect your investment with the Fire Magic® Stainless Steel Cleaner. Takes only a small amount to cut through grease and food build up. Removes most heat stains and rust spots.

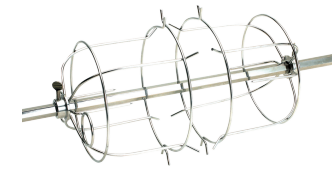

TURKEY HOLDER
MODEL: 3615E

This sturdy holder is also perfect for beef, pork and lamb roasts.



TURKEY FRYER KIT
MODEL: 3570

You'll be amazed at how tender a deep-fried turkey can be. Kit includes pot, inner basket with sturdy handle and thermometer probe. Great as a crab or corn pot.



ISLAND SYSTEMS

GLASS FIBER REINFORCED
CONCRETE ISLAND SYSTEMS

ISLAND SYSTEMS

Constructed from durable Glass Fiber Reinforced Concrete (GFRC) and easily assembled on site, these Island Systems are designed specifically for Fire Magic® equipment and make a stunning statement. Café Blanco island bases with contrasting polished GFRC Smoke counter tops provide a handsome concrete look.



MODEL: DC790-CBR-108SM

DIMENSIONS 273cm w x 88cm d x 90cm h



MODEL: DC430-CBR-75SM

DIMENSIONS 193cm w x 88cm d x 90cm h

*Fire Magic refrigerator is not CE certified



DOORS & DRAWERS

FLUSH MOUNTED



FLUSH MOUNTED
MODEL: 53920-SL

FLUSH MOUNTED

MOUNTED DOORS AND DRAWERS (5 Series)

Featuring heavy-duty handles with cast stainless steel mounts, these doors and drawers are designed to close flush with the frame using a strong magnetic latch. Flush Mounted Doors and Drawers are filled with polyurethane foam for insulation and a solid feel. A continuous rain guard protects from water getting into your custom enclosure. Available in a variation of door and drawer configurations and sizes. With so many options there is a combination available to meet any outdoor kitchen storage need.



DBL DOORS W/ DUAL DRAWERS
MODEL: 53930S-22
CUT-OUT: 53cm h x 78cm w x 52cm d



SINGLE ACCESS DOOR
MODEL: 53920-SL or SR
CUT-OUT: 53cm h x 37cm w



SINGLE ACCESS DOOR
MODEL: 53924-SL or SR
CUT-OUT: 64cm h x 45cm w

**DOORS &
DRAWERS**
FLUSH MOUNTED



SINGLE DOOR W/ DUAL DRAWERS
MODEL: 53820-SR or SL
CUT-OUT: 53cm h x 37cm w x 52cm d
Available w/ Louvers (-TSR or -TSL)



SINGLE ACCESS DOOR
MODEL: 53917-SR or SL
CUT-OUT: 46cm h x 62cm w



SINGLE ACCESS DOOR
MODEL: 53914-SR or SL
CUT-OUT: 38cm h x 52cm w



DOUBLE ACCESS DOOR
MODEL: 53930S
CUT-OUT: 53cm h x 76cm w



DOUBLE ACCESS DOORS
MODEL: 53934S
CUT-OUT: 38cm h x 76cm w



TRIPLE DRAWER
MODEL: 53803
CUT-OUT: 67cm h x 37cm w x 52cm d



DOUBLE DRAWER
MODEL: 53802
CUT-OUT: 40cm h x 37cm w x 52cm d



SINGLE DRAWER
MODEL: 53801
CUT-OUT: 13cm h x 37cm w x 52cm d



DBL DOORS W/ TRASH & DUAL DRAWERS
MODEL: 53930S-12
CUT-OUT: 53cm h x 78cm w x 52cm d
Available w/ Louvers (-12T) for propane tank



MASONRY DRAWER
MODEL: 53830-S
CUT-OUT: 37cm h x 82cm w x 56cm d



DOUBLE ACCESS DOORS
MODEL: 53938S
CUT-OUT: 41cm h x 99cm w



FIREMAGIC®

14724 PROCTOR AVE. CITY OF INDUSTRY, CA 91746
WWW.FIREMAGICGRILLS.COM

FIRE MAGIC® OUTDOOR GAS GRILL WARRANTY HIGHLIGHTS*

CRAFTED WITH PRIDE IN THE USA AND CONSTRUCTED ENTIRELY OF 304 STAINLESS STEEL, FIRE MAGIC® HAS BEEN MANUFACTURING THE FINEST OUTDOOR GRILLS YOU CAN BUY FOR OVER 75 YEARS. OUR WARRANTY COVERAGE REFLECTS THE QUALITY MATERIALS AND CRAFTSMANSHIP FOUND IN ALL FIRE MAGIC® GRILLS. WHEN INVESTING IN A GRILL, CONSIDER THE ASSURANCE PROVIDED BY THE FIRE MAGIC® WARRANTY:

You will find the Fire Magic® warranty to be the best and most comprehensive in the industry.

LIFETIME WARRANTY

CAST STAINLESS STEEL BURNERS, STAINLESS STEEL ROD COOKING GRIDS AND GAS GRILL HOUSINGS

FIFTEEN YEAR WARRANTY

BRASS VALVES, INNER LINERS, MANIFOLD ASSEMBLIES AND BACK BURNER ASSEMBLIES

FIVE YEAR WARRANTY

INFRARED BURNERS, FLAVOUR GRIDS AND CHARCOAL STAINLESS STEEL GRILLS AND SMOKERS

THREE YEAR WARRANTY

SIDE BURNERS AND ALL OTHER FIRE MAGIC GAS GRILL COMPONENTS

ONE YEAR WARRANTY

IGNITION SYSTEMS, ELECTRONIC COMPONENTS, GRILL ACCESSORIES AND CHARCOAL GRILL COMPONENTS

**See full warranty for complete details.*

All cut-out dimensions are for reference purpose only. Specifications are subject to change. Please refer to your instruction manual for the most up to date measurements.

